

JSY-MK-333 Three-phase embedded meter module

Product introduction

1.

- 1.1 Introduction
- 1.2 Features
- 1.3 Technical Parameters

2. Application

- 2.1 Appearance and installation
- 2.2 Terminal Definition
- 2.3 Typical wiring
- 2.4 Application Notes

3. Modbus register

4. Modbus communication protocol

5. Precautions

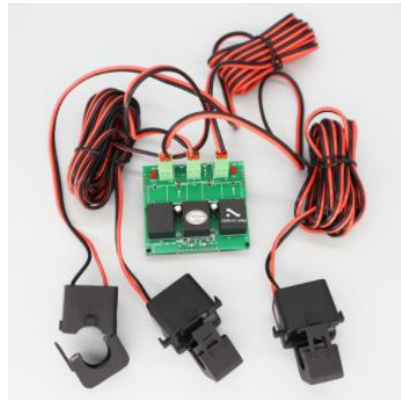
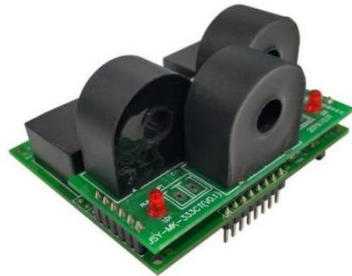

1. Product introduction

1.1. Brief introduction

JSY-MK-333 three-phase embedded metering module is a measurement product developed by our company using microelectronics technology and special large-scale integrated circuits, applying digital sampling processing technology and SMT process and other advanced technologies, and has completely independent intellectual property rights. The technical performance of the measurement module meets the relevant technical requirements of the IEC 62053-2 standard in the 1.0 three-phase active energy meter, and can directly and accurately measure the voltage, current, power, power factor, reactive energy and other electrical parameters in the three-phase AC grid with a rated frequency of 50Hz or 60Hz. The module has built-in 1 RS485 communication interface, 1 TTL interface, sampling MODBUS-RTU communication protocol, which is convenient for connection with various AMR systems, and has the characteristics of good reliability, small size, light weight, beautiful appearance and easy installation.

JSY-MK-333 three-phase embedded metering module can be widely used in energy-saving transformation, electric power, communications, railways, transportation, environmental protection, petrochemical, steel and other industries, used to monitor the current and power consumption of AC equipment.

1.2. Functional features

- 1.2.1. Collect three-phase alternating current parameters, including voltage, current, power, energy and other electrical parameters, complete information.
- 1.2.2. Adopt special measurement chip, effective value measurement method, high measurement accuracy.
- 1.2.3. With 1 RS-485 communication interface, 1 TTL communication port (3.3V).
- 1.2.4. The communication protocol adopts standard Modbus-RTU, which has good compatibility and is easy to program.
- 1.2.5. RS-485 communication interface with ESD protection circuit.
- 1.2.6. Two power supply methods are optional, which can be powered by fixed DC3.3V or DC 5~12V.
- 1.2.7. It adopts industrial-grade chip, built-in watchdog, and has perfect lightning protection and anti-interference measures to ensure reliability.
- 1.2.8. High isolation voltage, withstand voltage up to AC: 2500V.
- 1.2.9. Optional single-turn through-center transformer or open-close transformer with different specifications, which is convenient and easy to use.
(Note: The opening and closing current transformer is mainly used in industrial urban networks, power transmission systems, and rural project transformation
Easy installation, no need to disassemble the bus bar once, can also be operated with electricity, and does not affect the normal power consumption of customers, for the user transformation
The project saves a lot of manpower, material and financial resources and improves the efficiency of transformation.)
- 1.2.10. The module size is 65*57*41mm (length * width * height), small size, easy to embed into other systems.

1.3. Technical parameters

1.3.1 Three-phase AC input

- 1) Voltage range: three-phase four-wire input, 3*220/380V.
- 2) Current range: 50A, 80A,100A, 250A, 500A, etc. optional, external open current transformer model optional.
- 3) Signal processing: using special measurement chip, 24-bit AD sampling.
- 4) Overload capacity: 1.2 times the range can be sustainable. instantaneous (<200mS) current 5 times, voltage 2 times range is not damaged.
- 5) Input impedance: voltage channel> 1 kΩ /V.

1.3.2 Communication interface

- 1) Interface type: 1 RS-485 interface and 1 TTL interface (3.3V).
- 2) Communication protocol: MODBUS-RTU protocol.
- 3) Data format: software set, "n,8,1", "e,8,1", "o,8,1", "n,8,2".
- 4) Communication rate: The baud rate of the two-way communication interface can be set to 4800, 9600, 19200Bps, and the default communication format is, "n, 8, 1", 9600bps.
- 5) Communication data:

For voltage, current, power, energy and other electrical parameters, see the list of Modbus data registers

1.3.3 Measurement accuracy

Voltage, current, power: ±1.0%. Active electricity level 1.

1.3.4 power supply

- 1) When DC 3.3V is supplied, the peak voltage shall not exceed 3.6V. typical power consumption: ≤20mA.
- 2) When DC 5~12V power supply, the peak voltage shall not exceed 30V. Typical power consumption: ≤20mA.

1.3.5 isolation

Strong current and weak current are isolated by transformers, and the isolation withstand voltage > 2500V.

1.3.6 Working environment

- 1) Working temperature: -20~+60°C. Storage temperature: -40~+85°C.

- 2) Relative humidity: 5~95%, no condensation (at 40 °C).
- 3) Altitude: 0~3000m.
- 4) Environment: no explosion, corrosive gas and conductive dust, no significant shaking, vibration and shock place.

1.3.7 Temperature drift: ≤100ppm/°C.

1.3.8 Installation method: 2.54mm pitch pin row welding.

1.3.9 Module size: 65×57×41mm

2. Application

2.1. Product shape

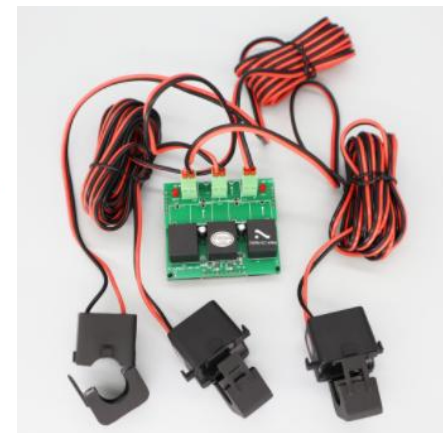
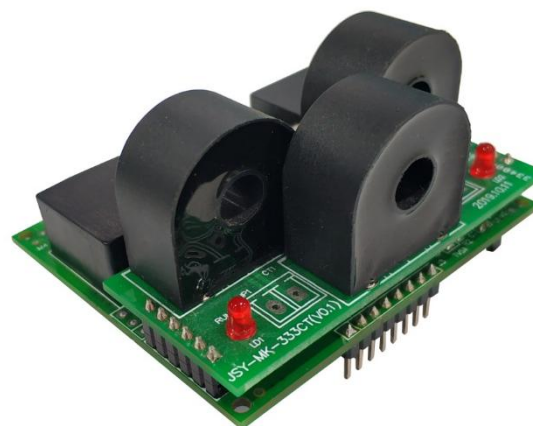
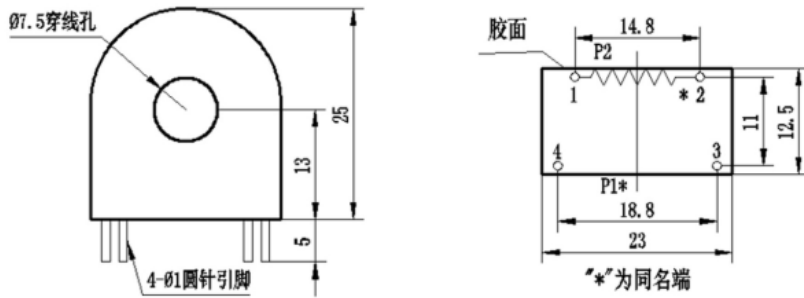

Figure 2.1 Product outline drawing



Outline dimension drawing of through-core current transformer

2.2、 Terminal definition

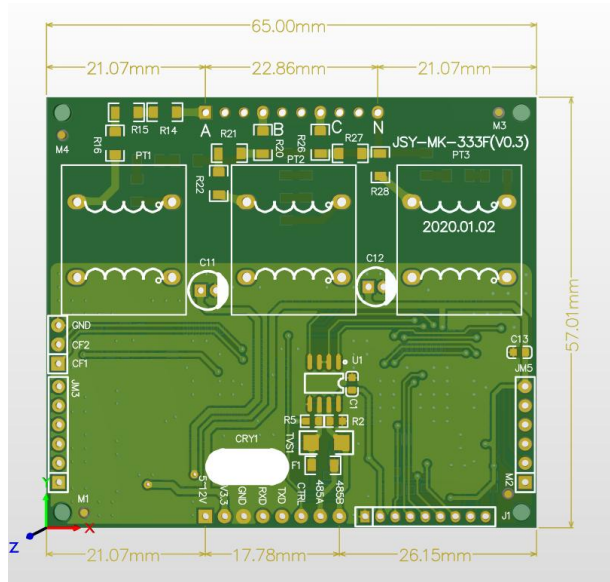
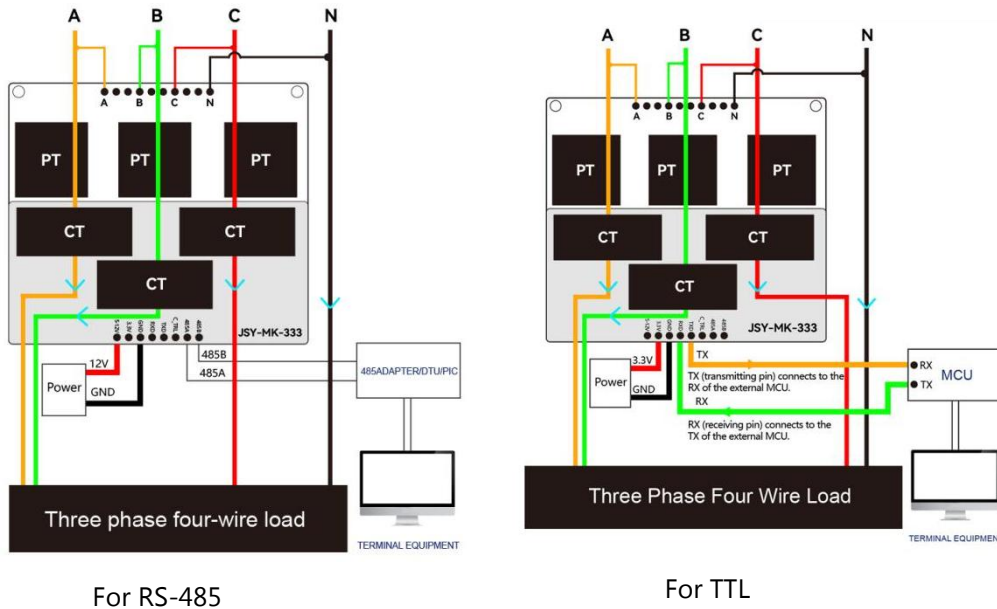

Figure 2.2.1 Product dimensions and functional pins

Terminal	illustrate
A	The voltage input of phase A under test
B	The voltage input of the B phase to be measured
C	The voltage input of the C phase under test
N	The input of the neutral line to be measured
5-12V	Wide voltage supply input positive (5~12VDC)
3.3V	3.3VDC power supply input positive pole (5-12V/3.3V two feet can only choose one).
GND	The power supply input is negative
RXD	TTL Receiver Pin (3.3V Level)
TXD	TTL transmit pin (3.3V level)
ALARM (customizable)	Alarm output pin, normal output low level, output high level when voltage and current exceed the upper limit, or phase sequence abnormality
485A	485 communication port A
485B	485 communication B port

Figure 2.2.2 Description of product function pins (Note: Pins not explained are empty feet).

2.3、 Typical wiring



2.4、 Application note

Please wire correctly according to the product specifications and models according to the above diagram. Be sure to disconnect all sources before wiring to avoid danger and damage to the equipment. Check that the wiring is correct, and then turn on the power supply for testing.

After the power is turned on, the "Power" running indicator is always on, and the "Communication" indicator flashes synchronously during communication data transmission.

When the product leaves the factory, it is set to the default configuration: address No. 1, baud rate 9600bps, data format "n,8,1", data update rate of 1000ms, conversion ratio of 1.

We can change the settings of product parameters and general testing of products through the JSY-MK-333 product testing software we provide.

2.4.1、 Connection to RS-485 network:

JSY-MK-333 module has RS-485 communication interface, the computer host generally

only RS-232 interface, at this time can be converted out of RS-485 interface through the RS-232 to RS-485 tool, the computer can communicate with JSY-MK-333. It is recommended to use RS-485 converter with isolation type to improve the reliability of the system.

A + end of all devices on a bus is connected in parallel, B- end is connected in parallel, not reversed, up to 255 network modules can be connected at the same time on a line, each network module can set its communication address, the communication connection should use a shielded twisted pair, the wire diameter is not less than 0.5mm². When wiring, the communication line should be kept away from strong electrical cables or other strong electric field environments.

The communication line of RS-485 should use shielded twisted pair. The communication distance of 485 can reach 1200 meters, when there are many RS485 devices connected to a bus, or when the baud rate is high, the communication distance will be shortened accordingly, and the 485 repeater can be used to expand.

RS-485 networking has a variety of topologies, generally using linear connection, that is, starting from the host host, multiple devices are connected to the network one after another from near and far. At the farthest end, a termination resistor of 120~300 Ω/0.25 watts can be connected (depending on the specific communication quality, that is, it is not necessary to install when the communication is good).

2.4.2、 Energy metering function:

It can provide three-phase voltage, current, power, power factor, active reactive energy and other parameters.

The electricity data is an unsigned number of 4 bytes, which will not overflow for 10 consecutive years, and the data will be saved when it is powered off.

JSY-MK-333 Modbus register list

Table 1: Measurement electrical parameter register and communication data sheet (function code 03H, readable only).

serial no.	definition	Register address	Read/Write	Data types and calculation descriptions
------------	------------	------------------	------------	---

1	A phase voltage	0100H	read	Unsigned number, value = DATA/100, unit V
2	Phase B voltage	0101H	read	Unsigned number, value = DATA/100, unit V
3	C-phase voltage	0102H	read	Unsigned number, value = DATA/100, unit V
4	Phase A current	0103H	read	Unsigned number, value = DATA/100, unit A
5	Phase B current	0104H	read	Unsigned number, value = DATA/100, unit A
6	C-phase current	0105H	read	Unsigned number, value = DATA/100, unit A
7	A-phase active power	0106H	read	Unsigned number, value = DATA, unit W
8	B-phase active power	0107H	read	Unsigned number, value = DATA, unit W
9	C-phase active power	0108H	read	Unsigned number, value = DATA, unit W
10	Three-phase active total power	0109H 010AH	read	Unsigned number, value = DATA, unit W (0109H register corresponds to the upper 16 bits)
11	A-phase reactive power	010BH	read	Unsigned number, value = DATA, unit var
12	B-phase reactive power	010CH	read	Unsigned number, value = DATA, unit var
13	C-phase reactive power	010DH	read	Unsigned number, value = DATA, unit var
14	Three-phase reactive total power	010EH 010FH	read	Unsigned number, value = DATA, unit var
15	A look at the power	0110H	read	Unsigned number, value = DATA, unit VA
16	B phase in power	0111H	read	Unsigned number, value = DATA, unit VA
17	C phase in power	0112H	read	Unsigned number, value = DATA, unit VA
18	Three-phase total apparent power	0113H 0114H	read	Unsigned number, value = DATA, unit VA (0114H register corresponds to the upper 16 bits)

19	Voltage frequency	0115H	read	Unsigned number, value = DATA/100 in Hz
20	Phase A power factor	0116H	read	Unsigned number, value = DATA/1000
21	Phase B power factor	0117H	read	Unsigned number, value = DATA/1000
22	C-phase power factor	0118H	read	Unsigned number, value = DATA/1000
23	Three-phase total power factor	0119H	read	Unsigned number, value = DATA/1000
24	A-phase active energy	011AH 011BH	read	Unsigned number, value = DATA/100 in kWh
25	B-phase active energy	011CH 011DH	read	Unsigned number, value = DATA/100 in kWh
26	C-phase active electrical energy	011EH 011FH	read	Unsigned number, value = DATA/100 in kWh
28	Three-phase active total electrical energy	0120H 0121H	read	Unsigned number, value = DATA/100 in kWh
29	A-phase reactive energy	0122H 0123H	read	Unsigned number, value = DATA/100 in kvarh
30	B-phase reactive energy	0124H 0125H	read	Unsigned number, value = DATA/100 in kvarh
31	C-phase reactive energy	0126H 0127H	read	Unsigned number, value = DATA/100 in kvarh
32	Three-phase reactive total electrical energy	0128H 0129H	read	Unsigned number, value = DATA/100 in kvarh
33	A look at electrical energy	012AH 012BH	read	Unsigned number, value = DATA/100 in kVAh
34	B looks at electrical energy	012CH 012DH	read	Unsigned number, value = DATA/100 in kVAh

35	C looks at electrical energy	012EH 012FH	read	Unsigned number, value = DATA/100 in kVAh
36	Three-phase vision in the total electrical energy	0130H 0131H	read	Unsigned number, value = DATA/100 in kVAh
37	Current power direction	0132H	read	High byte is not used, low byte bit7 ~ bit0 are total reactive, C phase reactive, B phase reactive, A phase reactive, total active, C phase active, B phase active, A phase active state corresponding bits (0 is forward, 1 is reverse), see status word 1
38	Current alarm status	0133H	read	When the high-byte bit0 is 1, it represents the reverse phase order, and it is normal for 0. Low byte bit6~bit4 is C~A phase current exceeding the standard, bit2~bit0 is C~A phase voltage exceeding the standard, see status word 2
39	Phase A forward active energy	0134H 0135H	read	Unsigned number, value = DATA/100 in kWh
40	B-phase forward active energy	0136H 0137H	read	Unsigned number, value = DATA/100 in kWh
41	C-phase forward active energy	0138H 0139H	read	Unsigned number, value = DATA/100 in kWh
42	Three-phase forward total active energy	013AH 013BH	read	Unsigned number, value = DATA/100 in kWh
43	A. Opposite active energy	013CH 013DH	read	Unsigned number, value = DATA/100 in kWh
44	B Opposite active energy	013EH 013FH	read	Unsigned number, value = DATA/100 in kWh
45	C Opposite active	0140H	read	Unsigned number, value = DATA/100 in kWh

	energy	0141H		
46	Third, there is always active energy in the opposite direction	0142H 0143H	read	Unsigned number, value = DATA/100 in kWh
47	Phase A forward reactive energy	0144H 0145H	read	Unsigned number, value = DATA/100 in kWh
48	B-phase forward reactive energy	0146H 0147H	read	Unsigned number, value = DATA/100 in kWh
49	C-phase forward reactive energy	0148H 0149H	read	Unsigned number, value = DATA/100 in kWh
50	Three-phase forward total reactive energy	014AH 014BH	read	Unsigned number, value = DATA/100 in kWh
51	A: Reactive energy in the opposite direction	014CH 014DH	read	Unsigned number, value = DATA/100 in kWh
52	B Opposite reactive energy	014EH 014FH	read	Unsigned number, value = DATA/100 in kWh
53	C reactive energy in the opposite direction	0150H 0151H	read	Unsigned number, value = DATA/100 in kWh
54	Third, the total reactive energy in the opposite direction	0152H 0153H	read	Unsigned number, value = DATA/100 in kWh

Table 2: System parameter register address and communication data table (function code 03H read, 10H write).

serial number	definition	Register address	Read/Write	Be specific
1	Model 1	0000H	read	The value is 333H
2	Hardware version	0001H	read	0x1001->V1.00.1
3	Software version	0002H	read	0x1001->V1.00.1
4	Protocol version	0003H	read	0x1001->V1.00.1
5	Address and baud rate	0004H	Read/Write	<p>The default value is 0106H. The default address is 01H and the default communication format is 8,N,1,9600bps</p> <p>Illustrate: High byte 8 bits for address, 1~255. 0 for broadcast address. The upper 2 bits of the low byte are the data format bits, "00" means 10 bits, no checksum, that is, "8,N,1". "01" means 11 bits, even, i.e. "8, E, 1". "10" means 11 bits, odd checks, i.e. "8,O,1". "11" means 11 bits, no checksum, 2 stop bits, i.e. "8, N, 2".</p> <p>The lower four bits of the low byte are the baud rate, 5-4800bps, 6-9600bps, 7-19200bps.</p> <p>(The communication baud rate of port 485 and TTL port is related to this register, and the baud rate of the two is the same)</p>

Table 3: Alarm upper limit register and communication data table (function code 03H read, 10H write).

serial number	definition	Register address	Read/Write	Be specific
1	Upper voltage limit	0020H	Read/Write	Default value 0x104=260V
2	Maximum current	0021H	Read/Write	The default value is 0x1F4, 0x1F4/10=50A

Table 4: Power direction registers (status word 1).

Bit7	Bit6	Bit5	Bit4	Bit3	Bit2	Bit1	Bit0
Total reactive power: 1—Reverse 0—Forward	C phase reactive power: 1—Reverse 0—Forward	Phase B reactive power: 1—Reverse 0—Forward	A phase reactive power: 1—Reverse 0—Forward	Always active: 1—Reverse 0—Forward	C phase is active: 1—Reverse 0—Forward	B phase work: 1—Reverse 0—Forward	A phase has a function: 1—Reverse 0—Forward

Table 5: Alarm status indication word meaning (status word 2):

Bit7	Bit6	Bit5	Bit4	Bit3	Bit2	Bit1	Bit0
Unused	C-phase current: 1—Overcurrent 0—Normal	Phase B current: 1—Overcurrent 0—Normal	A phase current: 1—Overcurrent 0—Normal	Unused	C phase voltage: 1—Overvoltage 0—Normal	Phase B voltage: 1—Overvoltage 0—Normal	A phase voltage: 1—Overvoltage 0—Normal

4. MODBUS communication protocol

This module provides a serial asynchronous half-duplex RS485 communication interface, using the standard MODBUS-RTU protocol, and various data information can be transmitted

on the communication line. Up to 255 modules can be connected simultaneously on a line, each module can set its communication address, the communication connection should use shielded twisted pair with copper mesh, wire diameter not less than 0.5mm². When wiring, the communication line should be kept away from strong electrical cables or other strong electric field environments.

The MODBUS protocol adopts the communication connection mode of master-slave response mode on a communication line. First, the signal of the master computer is addressed to a unique address of the terminal device (slave), and then, the response signal sent by the terminal device is transmitted to the host in the opposite direction, that is: on a separate communication line, the signal transmits all communication data in the opposite direction (half-duplex working mode). The MODBUS protocol only allows communication between the host (PC, PLC, etc.) and the terminal device, and does not allow data exchange between independent terminal devices, so that each terminal device does not occupy the communication line when they are initialized, but only responds to the query signal that reaches the machine.

Modbus protocol query response data flow

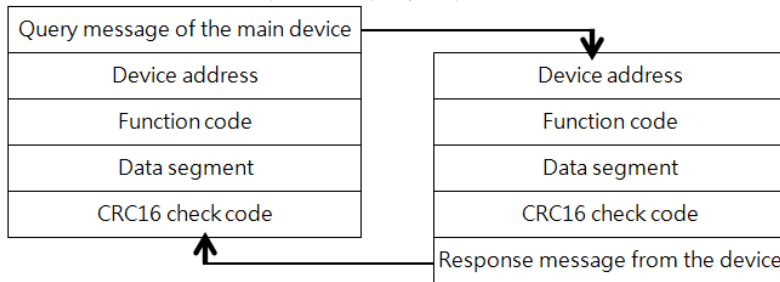

Host query: Query message frames include device address, function code, data information code, and check code. The address code indicates the slave device to be selected. The function code tells the selected slave what function to perform, for example, function code 03 or 04 is a requirement to read registers from the device and return their contents.

The data segment contains any additional information that the slave device wants to perform the function, the check code is used to verify the correctness of a frame of information, and the slave device provides a way to verify that the message content is correct, which uses the CRC16 calibration rules.

Slave response: If the slave device generates a normal response, there are slave address code, function code, data information code, and CRC16 check code in the response message. Data info codes include data collected from the device: like register values or states. If an error occurs, we agree that the slave will not respond.

We specify the communication data format to be used in this module: bits per byte (1 start bit, 8 data bits, odd or even or no check, 1 or 2 stop bits).

The structure of the data frame, i.e. the message format:

Device address	Feature code	Data segments	CRC16 checksum
1 byte	1 byte	N bytes	2 bytes (low byte first)

Device address: Consists of one byte, the address of each terminal device must be unique, and only the terminal addressed will respond to the corresponding query.

Function code: tells the endpoint to which it is addressed what function to perform. The following table lists the feature codes supported by the modules in this family and their functionality.

Feature code	function
03H	Read the value of one or more registers
10H	Write the value of one or more registers

Data segment: contains the data required by the terminal to perform a specific function or the data collected when the terminal responds to a query. The content of this data may be a numeric value, a reference address, or a set value.

Check code: CRC16 occupies two bytes and contains a 16-bit binary value. The CRC value is calculated by the transmitting device and then attached to the data frame, and the receiving device recalculates the CRC value when it receives the data and then compares it to the value in the received CRC domain, and if the two values are not equal, an error has occurred.

The process for generating a CRC16 is:

- (1) Preset a 16-bit register as 0FFFFH (all ones), called the CRC register.
- (2) The 8 bits of the first byte in the data frame are XOR with the lower bytes in the CRC register, and the result is stored back to the CRC register.
- (3) Move the CRC register one bit to the right, fill the highest bit with 0, and shift the lowest bit out and detect.
- (4) If the lowest bit is 0: repeat the third step (next shift). If the lowest bit is 1: XOR the CRC register with a preset fixed value (0A001H).
- (5) Repeat steps 3 and 4 until 8 shifts. This completes a full eight-bit process.
- (6) Repeat steps 2 through 5 to process the next octet until all byte processing is complete.
- (7) The value of the final CRC register is the value of CRC16.

Example of a MODBUS-RTU communication protocol:

4.1. Function code 0x03: read multiple registers

Example: The host wants to read the data of three slave registers with address 01 and start address 0100H

Host sends: 01 03 01 00 00 03 04 37

Address Function Code Start Address Data Length CRC Code

Slave Response: 01 03 06 56 11 56 22 56 33 1F 77

Address Function Code Number of Bytes Returned Register Data 1 Register 2 Register 3 CRC Code

4.2. Function code 0x10: write multiple registers

Example: The host should save 0104H, 01F4H to the slave register with address 0020H, 0021H (slave address code is 0x01)

Host sends: 01 10 00 20 00 02 04 01 04 01 F4 B1 9D

Address Function Code Start Address Number of Write Registers Byte Count Save Data 1 2 CRC Code

Slave response: 01 10 00 20 00 02 40 02

Address Function Code Start Address Number of Write Registers CRC Code

4.3. Description

The registers in the MODBUS-RTU protocol refer to 16 bits (i.e. 2 bytes) with the high bits

first.

When setting parameters, be careful not to write illegal data (that is, data values that exceed the data range limit).

The format of the error code returned by the slave is as follows:

Address code: 1 byte

Function code: 1 byte (maximum bit is 1)

Error code: 1 byte

CRC: 2 bytes

The response is echoed with the following error code:

81: Illegal function code, that is, the received function code module does not support it.

82: Read or write an illegal data address, that is, the data location is outside the module's readable or writable address range.

83: Illegal data value, that is, the module receives data value sent by the host beyond the data range of the corresponding address.

4.4. Examples of communication messages

4.4.1 Read data register (function code 03H): read the 3 register values of the three-phase voltage, and the result is: A phase voltage 220.33V, B phase voltage 220.5V, C phase voltage 220.67V, module address 1.

Host read dataframe:

addr ess	com man d	Start address (high first)	Number of registers (high first)	Check digit (low first)
01H	03H	01H,00H	00H,03H	04H,37H

The module responds to the data frame:

address	command	Data length	Data segment (6 bytes)	Checksum
01H	03H	06H	56H,11H,56H,22H,56H,33H	1FH,77H

4.4.2 Write data register (function code 10H): set the upper limit voltage to 260V, the upper limit current to 50A, and the module address to 1.

Host writes data frame:

addr ess	comm and	Start address	Number of registers	Number of bytes	Data segments	Checksum
01H	10H	00H,20H	00H,02H	04H	01H,04H,01 H,F4H	B1H,9DH

The module responds to the data frame:

address	command	Start address	Number of registers	Checksum
01H	10H	00H,20H	00H,02H	40H,02H

4.4.3 Clear all energy data (function code 10H, write 2 registers starting from 000CH, write data is 4 bytes of 00H):

addr ess	com mand	Start address	Number of registers	Number of bytes	Data segments	Checksum
01H	10H	00H,0C H	00H,02H	04H	00H,00H,00 H,F0H	F3H,FAH

The module responds to the data frame:

address	command	Start address	Number of registers	Checksum
01H	10H	00H,0CH	00H,02H	81H,CBH

V. Precautions

- 1) Pay attention to the auxiliary power information on the product label, the auxiliary power grade and polarity of the product cannot be connected wrong, otherwise the product may be damaged.
- 2) Please wire correctly according to the product specifications and models according to the diagram. Before wiring, make sure to disconnect all signal sources and power supplies to avoid danger and damage to the equipment. Check that the wiring is correct, and then turn on the power supply for testing.
- 3) The voltage loop or the secondary circuit of PT must not be short-circuited.
- 4) When there is current on the primary side of CT, the secondary circuit of CT is strictly prohibited to open circuit. It is strictly forbidden to wire live or unplug terminals.
- 5) When the product is used in an environment with strong electromagnetic interference, please pay attention to the shielding of the input and output signal lines.
- 6) When installing centrally, the minimum installation interval should not be less than

10mm.

- 7) This series of products is not equipped with lightning protection circuit, when the input and output feeders of the module are exposed to the outdoor harsh climate environment, attention should be paid to take lightning protection measures.
- 8) Do not damage or modify the label and logo of the product, do not disassemble or modify the product, otherwise the company will no longer provide "three guarantees" (replacement, return, repair) service for the product.

Manufacturer: Shenzhen Jiansiyan Technologies Co., Ltd.

Online Technical Support Staff:

+86 18675534520(Mr.Jahleel)

+86 18665924579(Mr.Jimmy)

E-mail: jsykj@outlook.com

Web: www.jsypowermeter.com

Address: 901, Building 1, Tajiale Technology Industrial Park, Tongguan Road, Tianliao Community, Yutang Street, Guangming District, Shenzhen, Guangdong, 518100, China.



official website